

# Locking Devices

Lockcases | Cylinders | Standards



# Technical Details

BS EN 12209: 2003 Mechanically operated locks, latches and locking plates.

Products tested to British and European standards provide greater durability, longer warranty periods, peace of mind and evidence of professional specification.

Under the standard each product is tested and classified accordingly to show its compliance.

The identification of an 11-digit code is visible on the individual product. Each digit represents a category and how it measured against the standard to which it was tested.

## Digit 1: Category of use

1 = Light use. For use by people with a high incentive to exercise care and with a small chance of misuse.

2 = Normal use. For use by people with some incentive to exercise care but where there is some chance of misuse.

3 = Extreme use. For use by people where there is little incentive to exercise care and where there is a high chance of misuse.

## Digit 2: Durability

A = 50,000 test cycles; no load on latch bolt.

B = 100,000 test cycles; no load on latch bolt.

C = 200,000 test cycles; no load on latch bolt.

F = 50,000 test cycles; 10 N load on latch bolt.

G = 100,000 test cycles; 10 N load on latch bolt.

H = 200,000 test cycles; 10 N load on latch bolt.

L = 100,000 test cycles; 25 N load on latch bolt.

M = 200,000 test cycles; 25 N load on latch bolt.

R = 100,000 test cycles; 50 N load on latch bolt.

S = 200,000 test cycles; 50 N load on latch bolt.

W = 100,000 test cycles; 120 N load on latch bolt.

X = 200,000 test cycles; 120 N load on latch bolt.

## Digit 3: Door mass and closing force

1 = up to 100kg door mass; 50 N maximum closing force.

2 = up to 200kg door mass; 50 N maximum closing force.

3 = above 200kg door mass or specified by the manufacturer; 50 N maximum closing force.

4 = up to 100kg door mass; 25 N maximum closing force.

5 = up to 200kg door mass; 25 N maximum closing force.

6 = above 200kg door mass or specified by the manufacturer; 25 N maximum closing force.

7 = up to 100kg door mass; 15 N maximum closing force.

8 = up to 200kg door mass; 15 N maximum closing force.

9 = above 200kg door mass or specified by the manufacturer; 15 N maximum closing force.

## Digit 4: Suitability for use on fire/smoke doors

0 = not approved for use on fire/smoke resisting door assemblies.

1 = suitable for use on fire/smoke resisting assemblies, subject to satisfactory assessment of the contribution of the lock or latch to the fire resistance of specified fire/smoke resisting door assemblies.

## Digit 5: Safety

Only 1 grade of safety is identified.

0 = no safety requirement.

## Digit 6: Corrosion resistance and temperature

0 = no defined corrosion resistance, no temperature requirement.

A = low corrosion resistance, no temperature requirement.

B = moderate corrosion resistance, no temperature requirement.

C = high corrosion resistance, no temperature requirement.

D = very high corrosion resistance, no temperature requirement.

E = moderate corrosion resistance, temperature requirement from -20°C to +18°C.

F = high corrosion resistance, temperature requirement from -20°C to +18°C.

G = very high corrosion resistance, temperature requirement from -20°C to +18°C.

## Digit 7: Security and drill resistance

1 = minimum security and no drill resistance.

2 = low security and no drill resistance.

3 = medium security and no drill resistance.

4 = high security and no drill resistance.

5 = high security with drill resistance.

6 = very high security and no drill resistance.

7 = very high security with drill resistance.

## Digit 8: Field of door application

15 grades of door application are identified and summarised in the table below:

Grade	Type	Application 1	Application 2	Application 3
A	Mortice	Unrestricted application		
B	Mortice	Hinged door		
C	Mortice	Sliding door		
D	Rim	Unrestricted application		
E	Rim	Hinged door		
F	Rim	Sliding door		
G	Bored lock	Unrestricted application		
H	Mortice	Hinged door	Supported	
J	Rim	Hinged door	Inwards	
K	Mortice	Hinged door		Locked from inside
L	Mortice	Sliding door		Locked from inside
M	Rim	Hinged door		Locked from inside
N	Rim	Sliding door		Locked from inside
P	Mortice	Hinged door	Supported	Locked from inside
R	Rim	Hinged door	Inwards	Locked from inside

# Technical Details

BS EN 12209:2003 Mechanically operated locks, latches and locking plates.

## Digit 9: Type of key operation and locking

- 0 = not applicable.
- A = cylinder lock or latch, manually locking.
- B = cylinder lock or latch, automatically locking.
- C = cylinder lock or latch, manually locking with intermediate locking.
- D = lever lock or latch, manually locking.
- E = lever lock or latch, automatically locking.
- F = lever lock or latch, manually locking with intermediate locking.
- G = lock or latch without key operation, manually locking.
- H = lock without key operation, automatically locking.

## Digit 10: Type of spindle operation

- 0 = lock or latch without follower.
- 1 = lock or latch for knob or sprung lever handle operation.
- 2 = lock or latch for unsprung lever handle operation.
- 3 = lock or latch for heavy duty unsprung lever handle operation.
- 4 = lock or latch for heavy duty unsprung lever handle operation specified by the manufacturer.

## Digit 11: Key identification requirement

- 0 = no requirements.
- A = minimum three detaining elements.
- B = minimum five detaining elements.
- C = minimum five detaining elements, extended number of differs.
- D = minimum six detaining elements.
- E = minimum six detaining elements, extended number of effective differs.
- F = minimum seven detaining elements.
- G = minimum seven detaining elements extended number of effective differs.
- H = minimum eight detaining elements, extended number of effective differs.

## Example:

2 H 5 1 0 E 5 A F 2 C

The above code signifies a mechanically operated lock and locking plate for use in an application where people have an incentive to exercise care, able to withstand a durability of 200,000 cycles with a 10 N load on the latch bolt, on a door with a mass of up to 200kg and a maximum closing force of 25N, suitable for use on a fire/smoke resisting door assembly, no safety requirement, moderate corrosion resistance in temperatures ranging from -20°C to +18°C, with high security and drill resistance for any use in any mortice application, with a manual locking lever lock or latch unsprung lever handle operation, a minimum of five deadlocking elements and an extended number of effective differs.

## Marking:

The standard requires the following additional information to accompany the CE Marking required for locks and latches intended for use on fire resisting doors and smoke control doors.

- a) The identification number of the notified certification body.
- b) The name or identifying mark of the manufacturer.
- c) The registered address of the manufacturer.
- d) The last two digits of the year in which the marking was applied.
- e) The number of the EC certificate of conformity, reference to EN 12209:2003.
- f) The classification code of the product.

# Euro Locks



European lock case range produced to DIN standards and dimensions, offering reliable heavy duty locks in standard applications.

All 55mm backset only.

Single throw deadbolt locks are suitable for use with unsprung lever handles.

Investment casting of the followers and guided deadbolt mechanism make this a severe duty range.

Available radius and square.

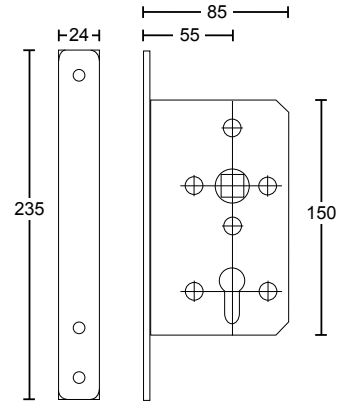

Deadlock

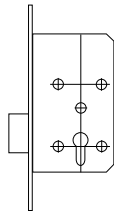

IL001

Sashlock

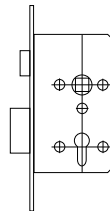

IL002

Bathroom Lock

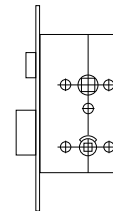

IL003

Latch

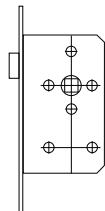

IL004

Escape Nightlatch

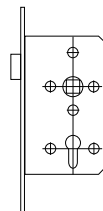

IL005

Anti-thrust Escape Nightlatch

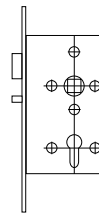

IL006

Anti-panic Sashlock

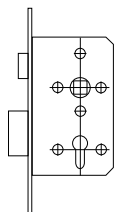

IL007



## FINISHES

Satin stainless steel  
Polished brass



## STANDARDS

BS EN 12209  
Certifire Approved  
Produced to DIN Standards and dimensions



## REBATE SETS

12mm and 25mm rebate sets are available.

# Versatile Locks



A comprehensive series of locks giving standard and special applications.

Heavy duty high security locking options.

The same case accepts British oval and European profile cylinders. Available with square or radius forend.

All locks come with boxed keeps.

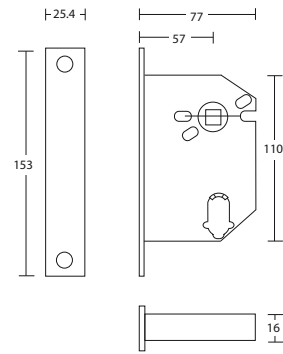

## HEAVY DUTY-HIGH SECURITY

Sashlock

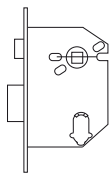

IL010

Deadlock



IL011

Bathroom Lock

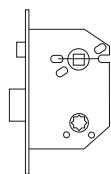

IL012

Latch

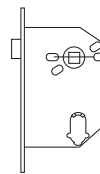

IL013

Deadbolt  
30 x 11mm  
20 mm throw

Latchbolt  
11.5mm throw

## HEAVY DUTY AUTO DEADLOCKING

Nightlatch Snib Holdback

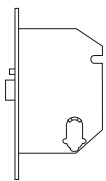

IL014

Nightlatch No Holdback

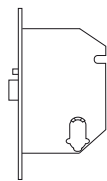

IL015

Escape Nightlatch No Holdback

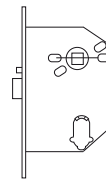

IL016

Escape Nightlatch Snib Holdback

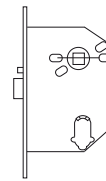

IL017

Escape nightlatch non deadlocking version IL018

## HEAVY DUTY HIGH SECURITY SPECIAL APPLICATION LOCKS

Escape Sashlock

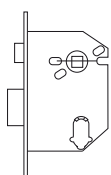

IL019

Internal – lift lever to lock depress lever to withdraw latch and deadbolt simultaneously  
External – lever operates latch bolt only, cylinder operates deadbolt

Escape Deadlock

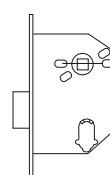

IL020

Internal – lift lever to lock depress lever to unlock

External – cylinder operates deadbolt

Both locks must use single cylinders only

# Modular Lockcases



This severe duty range of locks offer a vast array of interchangeable applications. Using a symmetrical modular system gives the ability to change the function of the door easily. Compatible with Scandinavian oval cylinders only. The cylinder follower is above the handle line. Supplied with radius forends, ideal for factory prepared doors. Lockcases have a substantial 21mm throw deadbolt and 14mm projecting latchbolt. Uses unsprung lever handles only.

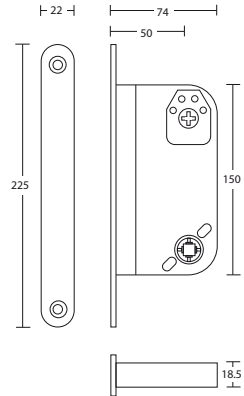

For BS EN179 escape functions, refer to Escape Hardware brochure.

## SASHLOCK

Standard

High Security

Escape Function

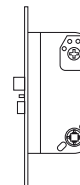
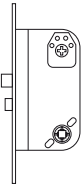
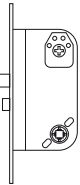

For bathroom lock use either standard sashlock or standard deadlock with 62.0500 5mm follower conversion for use with indicator and turn.

Case  
50mm  
70mm

IL021-A  
IL021-B

IL022-A  
N/A

IL023-A  
IL023-B

## DEADLOCK

Standard

High Security

Sliding Door  
(hookbolt)

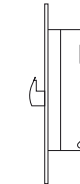
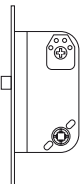
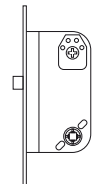

Case  
50mm  
70mm

IL024-A  
IL024-B

IL025-A  
IL025-B

IL026-A  
N/A

## NIGHTLATCH (AUTO-DEADLOCKING)

With Snib  
Holdback

With Faceplate  
Key Holdback

No Holdback

Non Auto-  
Deadlocking

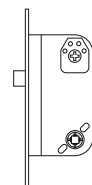
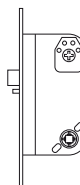
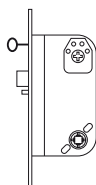
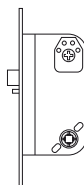

Case  
50mm  
70mm

IL027-A  
IL027-B

IL028-A  
IL028-B

IL029-A  
IL029-B

IL030-A  
IL030-B

# Modular Lockcases

## ESCAPE NIGHT RICH – AUTO DEADLOCKING

Heavy Sprung  
No Hold Open

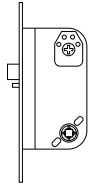

50mm  
70mm

IL031-A  
IL031-B

Heavy Sprung  
Faceplate Key  
Holdback

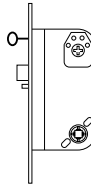

IL032-A  
IL032-B

Heavy Sprung  
No Hold Open  
Non Deadlocking

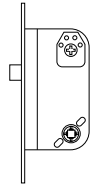

N/A  
IL032-B

Light Sprung  
No Hold Open

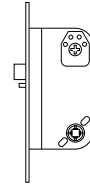

IL033-A  
IL033-B

Light Sprung  
Faceplate Key  
Holdback

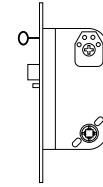

IL034-A  
IL034-B

## DOUBLE LATCH LOCK (AUTO-DEADLOCKING)

## LATCH

With Snib Holdback

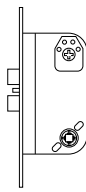

50 mm  
70 mm

IL036-A  
IL037-B

With Faceplate  
Key Holdback

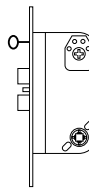

IL037-A  
IL037-B

No Holdback

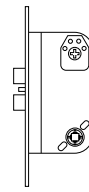

IL038-A  
IL038-B

Escape Function

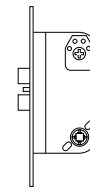

IL039-A  
IL039-B

Standard Latch

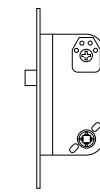

IL040-A  
IL040-B



### FINISHES

SCP – Satin chrome plated  
PB – Polished brass plated  
PCP – Polished chrome plated



### HANDING DETAILS

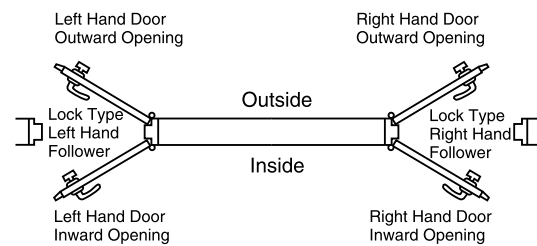

### STANDARDS

BS EN 12209



### REBATE SETS

13mm, 19mm and 25mm rebate sets are available.

# British Locks



A traditional range of locks to typical British dimensions, giving standard locking functions applicable to most common uses. Available pierced to take British Oval and Euro cylinders or 5 lever, where applicable. Light sprung (LS) or heavy sprung (HS) dependent on furniture selected. Brass latch and deadbolt with hardened steel rollers.

Detailed here are just a few functions. There are many special applications and non-standard locking solutions. Please contact Lloyd Worrall for further information.

## SASHLOCK

British Oval  
Cylinder

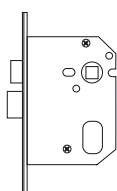

IL041-A  
IL041-B  
IL041-C

European  
Profile Cylinder

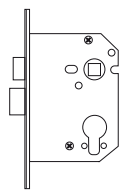

IL042-A  
IL042-B  
IL042-C

5 Lever  
Locking

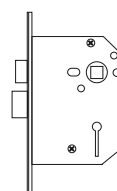

IL043-A  
IL043-B  
IL043-C

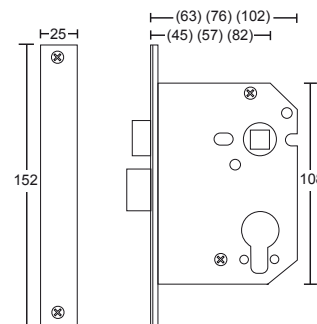

Case  
63mm  
76mm  
102mm

## DEADLOCK

British Oval  
Cylinder

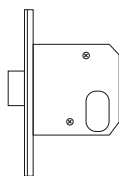

IL044-A  
IL044-B  
IL044-C

European  
Profile Cylinder

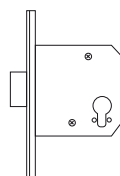

IL045-A  
IL045-B  
IL045-C

British Oval  
Cylinder Clawbolt

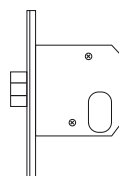

N/A  
IL046-B  
N/A

5 Lever  
Locking

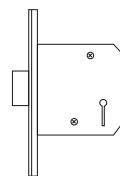

IL047-A  
IL047-B  
N/A

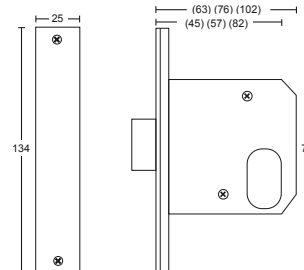

Case  
63mm  
76mm  
102mm

## BATHROOM LOCKS

5mm Deadbolt  
Follower Sashlock

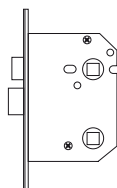

IL048-A  
IL048-A  
IL048-C

8mm Deadbolt  
Follower Sashlock

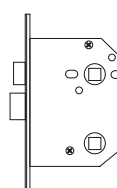

IL049-A  
IL049-B  
IL049-C

5mm Deadbolt  
Follower

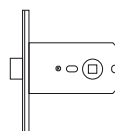

N/A  
IL050-B  
N/A

8mm Deadbolt  
Follower

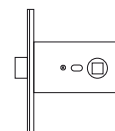

N/A  
IL051-B  
N/A

Case  
63mm  
76mm  
102mm

Backset  
45mm  
57mm  
82mm

# British Locks

## LATCH

Upright  
Mortice Latch

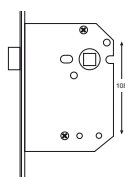

Small Case  
Mortice Latch

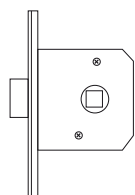

Pocket Case  
Mortice Latch

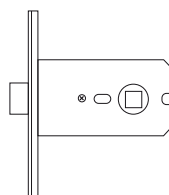

Case  
63mm  
76mm  
102mm

IL052-A  
IL052-B  
IL052-C

IL053-A  
IL053-B  
N/A

N/A  
IL054-B  
N/A

Backset  
45mm  
57mm  
82mm

## HORIZONTAL

British Oval  
Cylinder Sashlock

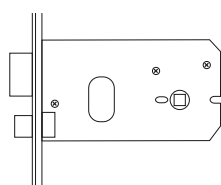

5 Lever  
Locking Sashlock

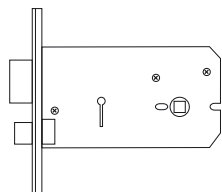

Mortice Bathroom  
Lock

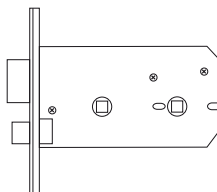

Mortice Latch

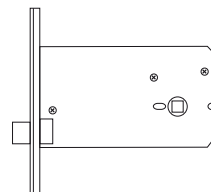

Case  
127mm  
151mm

IL055-A  
IL055-B

IL056-A  
IL056-B

IL057-A  
IL057-B

IL058-A  
IL058-B

Backset  
45mm  
57mm

Centres  
57mm  
70mm

## INDICATOR BOLTS

Suitable for 13mm and 20mm board. Concealed bolt through fixings. Satin stainless steel. Keep sold separately.



IL201 Turnbolt with indicator release.



IL202 Extended turnbolt with indicator release.



IL203 Budget turnbolt with indicator release.



### REBATE SETS

13mm, 19mm and 25mm rebate sets are available.



### OPTIONS

5 lever locks available master keyed or keyed alike.



### FINISHES

Satin stainless steel, brass, bronze metal, antique, polished chrome.

# Narrow Style Locks



A narrow style range of locks for the fabrication market.

Covering all the popular functions this is an ideal accompaniment to the other ranges.

Standard stock backset of 30mm.

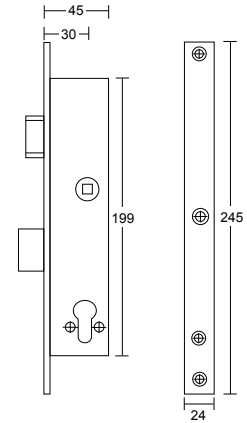

Sashlock

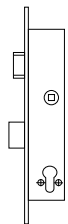

IL060

Rollerbolt Sashlock

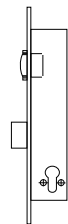

IL061

Anti-panic Lock

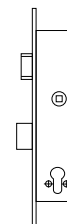

IL062

Deadlock

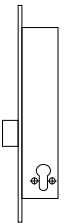

IL063

Sliding Door Lock

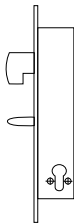

IL064

Small Case Deadlock

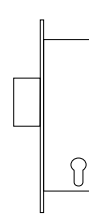

IL065

Escape Nightlatch

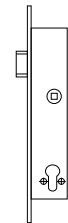

IL066

Latch

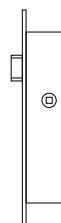

IL067



## FINISHES

SSS – Satin stainless steel.



## OPTIONS

Also available in 25mm, 35mm, 40mm and 45mm backset.



## STANDARDS

BSEN 12209.  
DIN 18251.

# Detainer Locks

## NIGHTLATCH

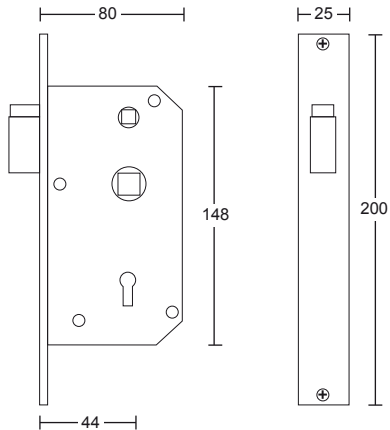

Internal handle, external key, with snib holdback facility.

IL070-LH Lockable Internal Handle LH  
IL070-RH Lockable Internal Handle RH

IL071-LH Non-lockable Internal Handle LH  
IL071-RH Non-lockable Internal Handle RH

13mm, 19mm and 25mm rebate sets are available.

Most door furniture can be used with this lock with minor adjustment.  
Please indicate which door furniture is to be used with these locks.

## SASH LOCK

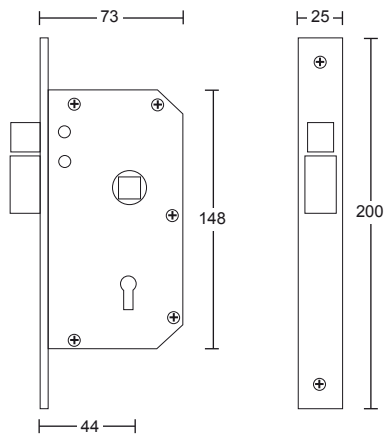

IL072 Standard Sashlock Function

13mm, 19mm and 25mm rebate sets are available.

Most door furniture can be used with this lock with minor adjustment.  
Please indicate which door furniture is to be used with these locks.

## 5 LEVER LOCKS

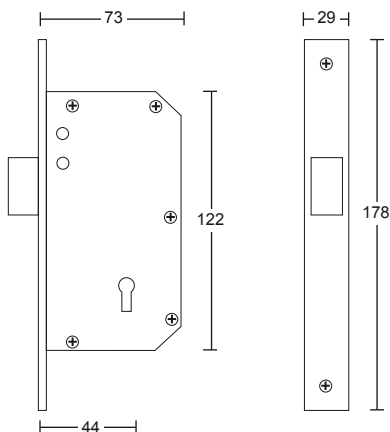

IL073 Standard Deadlock Function

13mm, 19mm and 25mm rebate sets are available.



### FINISHES

SSS – Satin stainless steel.  
BRS – Brass.



### STANDARDS

CE Marked.  
BS3621-1997 (IL073)



### OPTIONS

Restricted key duplication (RKS). Master keyed with each other (MK).  
Can be fitted with microswitch. Single Pole (SP) or Double pole (DP).

# Cylinders

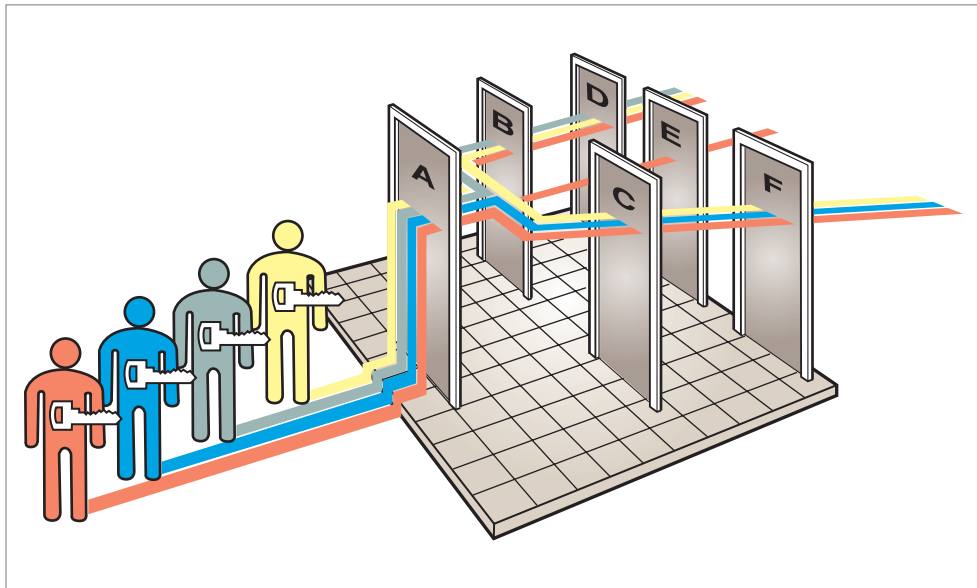

# Technical Details

## BS EN 1303: 2005 Revision 1 Cylinders for Locks Requirements and Test Methods

Products tested to British and European standards provide greater durability, longer warranty periods, peace of mind and evidence of professional specification.

Under the standard each product is tested and classified accordingly to show its compliance. The identification of an 8-digit code is visible on the individual product. Each digit represents a category and how it measured against the standard to which it was tested.

### Digit 1: Category of use

Only one category is identified.

1 = keys shall resist a torque of 2.5Nm and still be usable.

### Digit 2: Durability

Three grade of durability will classify cylinders as either grade 4, 5 or 6 based on the number of test cycles achieved.

4 = 25,000 cycles.

5 = 50,000 cycles.

6 = 100,000 cycles.

Key strength is also tested to ensure there is no failure of the key within the durability test.

### Digit 3: Door mass

No requirement.

### Digit 4: Fire resistance

0 = no requirement.

1 = cylinders shall be fire tested in accordance with current fire test requirements or BS EN 1634-1.

### Digit 5: Safety

No requirement.

### Digit 6: Corrosion resistance

0 = no requirement.

A = conforms to grade 3 of BS EN 1670 as a minimum.

B = will resist temperature extremes of -20/+80°C

C = conforms to grade 3 of BS EN 1670 as a minimum and will resist temperature extremes of -20/+80°C.

### Digit 7: Key security

Cylinders are classified in grades 1 to 6, where 6 is the highest. The grade can differ from one side of a double cylinder to the other. The table below provides a summary of the main security criteria:

Requirement	Unit	Grades					
		1	2	3	4	5	6
Min number of effective differs	Number	100	300	15,000	30,000	30,000	100,000
Min number of movable retainers	Number	3	3	5	5	6	6
Max number of steps	-	100	70	60	60	60	50
Direct coding on key	%	Yes	Yes	No	No	No	No
Torque resistance of plug/cylinder	Nm	2.5	5	15	15	15	15

### Digit 8: Attack resistance

Cylinders are classified in grades 0, 1 and 2, where 2 is the highest. The table below provides a summary of the main requirements:

	Grade		
	0	1	2
Resistance to drilling (nett drilling time)	-	3 mins	5 mins
Resistance to chisel attack (number of defined blows)	-	30	40
Resistance to twisting attack (number of defined twists)	-	20	30
Resistance to plug/cylinder extraction (pull load)	-	15 kN	15 kN

Example:

1 6 - 0 - B 3 1

The above code signifies a cylinder meeting the required category of use, durability grade 6 with no fire resistant requirement, will resist temperature extremes of -20/+80 °C, has a grade 3 key security and grade 1 attack resistance.

Marking:

This standard requires that the classification relevant to the cylinder shall be quoted in the accompanying documentation, on its labelling or packing and/or by marking the product itself or by more than one of these methods.

The marking/labelling shall include the following:

- a: manufacturer's name or trademark, or other means of identification,
- b: product model identification,
- c: the 8 digit classification listed above,
- d: number of this European standard.



# 11 pin patented cylinders



Six pin tumblers plus sidebar mechanism with five sidepins. Mechanism and keyblanks are protected by worldwide patents. Incorporates anti-drill and anti-pick protection. 1.9 billion usable combinations. Dual security levels may be combined with lower cost medium security cylinders in the same system. Designed for large or complex master key systems. Assembled in our workshop facility.

There is a strict registration procedure and all keys are uniquely marked for greater key control.

## CYLINDER WITH THUMB TURNS

Oval Turn (7)

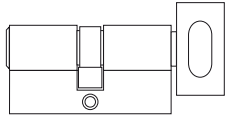

Stainless Steel (6)  
Turn (Large)

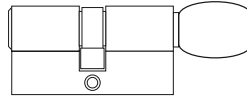

Euro



IL102-A  
IL102-B  
IL102-C

IL103-A  
IL103-B  
IL103-C

61mm  
71mm  
81mm

Oval



IL109-A  
IL109-B  
IL109-C

IL110-A  
IL110-B  
IL110-C

61mm  
71mm  
81mm

Stainless Steel (9)  
Turn (Small)

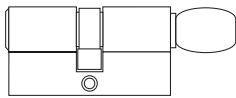

Large Turn (1)

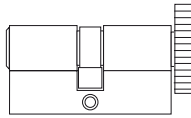

Euro



IL104-A  
IL104-B  
IL104-C

IL105-A  
IL105-B  
IL105-C

61mm  
71mm  
81mm

Oval



IL111-A  
IL111-B  
IL111-C

IL112-A  
IL112-B  
IL112-C

61mm  
71mm  
81mm

## SINGLE TURN

Oval Turn (7)



Turn Large (6)

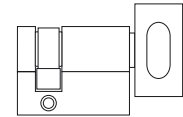

Round Turn (1)



Turn Small (9)



Euro



IL107-A 40mm  
IL107-B 45mm  
IL107-C 50mm

Oval



IL113-A 40mm  
IL113-B 45mm  
IL113-C 50mm

Specify Turn (1,6,7 or 9) when ordering.



Finishes

1, 7: SCP, PCP, PB. 6, 9: SSS.

# 11 pin patented cylinders

## DOUBLE

## SINGLE

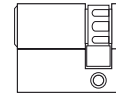
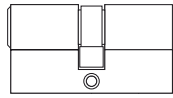

### Euro



61mm	IL101-A
71mm	IL101-B
81mm	IL101-C

40mm	IL106-A
45mm	IL106-B
50mm	IL106-C

### Oval



61mm	IL108-A
71mm	IL108-B
81mm	IL108-C

40mm	IL114-A
45mm	IL114-B
50mm	IL114-C

## SINGLE OUTSIDE

## SINGLE INTERNAL

### Scandinavian Oval

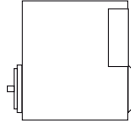
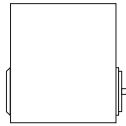
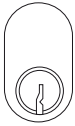

IL115

IL116

### IL117

Scandinavian double cylinder consists of 1 each of IL115 and IL116.

## RIM CYLINDER

## SCREW IN MORTICE CYLINDER

### Round

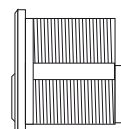
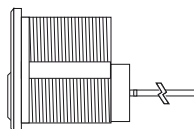
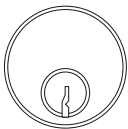

IL118

IL119

## PADLOCKS

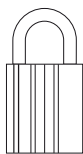

IL120

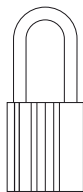

IL121

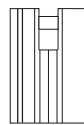

IL122

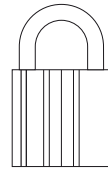

IL123

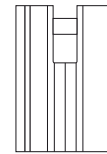

IL124

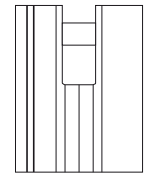

IL125



### Finishes

Satin chrome plated, polished chrome plated, polished brass, black chrome (padlocks).



### Standards

International Patent protected. BS EN 1303 grade 5 cylinder. BS EN 12320 grade 3 to 6 padlocks.

# 5 pin patented cylinders



A medium security five pin tumbler with longitudinal pin. Mechanism and key blanks are protected by international patents.

29,000 - usable differs for small to medium size master key systems.

Assembled in our own workshops.

## cylinder with thumbturns

### Oval Turn (7)

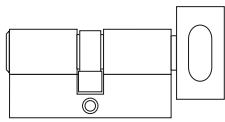

### Stainless Steel (6) Turn (Large)

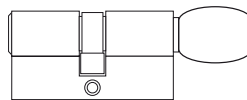

Euro



IL130-A  
IL130-B  
IL130-C

IL131-A  
IL131-B  
IL131-C

61mm  
71mm  
81mm

Oval



IL134-A  
IL134-B  
IL134-C

IL135-A  
IL135-B  
IL135-C

61mm  
71mm  
81mm

### Stainless Steel (9) Turn (Small)

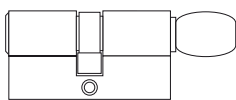

### Large Turn (1)

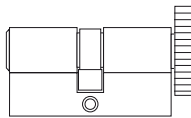

Euro



IL132-A  
IL132-B  
IL132-C

IL133-A  
IL133-B  
IL133-C

61mm  
71mm  
81mm

Oval



IL136-A  
IL136-B  
IL136-C

IL137-A  
IL137-B  
IL137-C

61mm  
71mm  
81mm

## Single Turn

### Oval Turn (7)



### Turn Large (6)



### Round Turn (1)



### Turn Small (9)

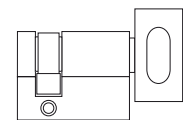

Euro



IL138-A 40mm  
IL138-B 45mm  
IL138-C 50mm

Oval



IL139-A 40mm  
IL139-B 45mm  
IL139-C 50mm

Specify Turn (1,6,7 or 9) when ordering.



### Finishes

1, 7: SCP, PCP, PB. 6, 9: SSS.

# 5 pin patented cylinders

## DOUBLE

## SINGLE

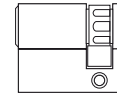
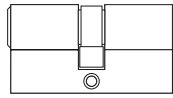

### Euro



61mm	IL140-A
71mm	IL140-B
81mm	IL140-C

40mm	IL141-A
45mm	IL141-B
50mm	IL141-C

### Oval



61mm	IL142-A
71mm	IL142-B
81mm	IL142-C

40mm	IL143-A
45mm	IL143-B
50mm	IL143-C

## SINGLE OUTSIDE

## SINGLE INTERNAL

### Scandinavian Oval

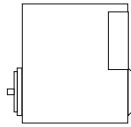
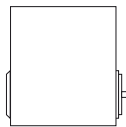
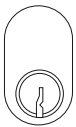

IL144

IL145

### IL117

Scandinavian double cylinder consists of 1 each of IL144 and IL145.

## RIM CYLINDER

## SCREW IN MORTICE CYLINDER

### Round

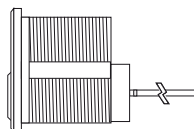
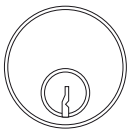

IL146

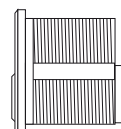

IL147

## PADLOCKS

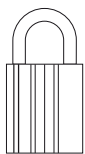

IL148

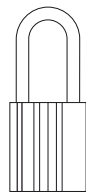

IL149

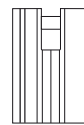

IL150

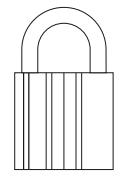

IL151



### Finishes

Satin chrome plated, polished chrome plated, polished brass, black chrome (padlocks).



### Standards

International Patent protected. BS EN 1303 grade 4. BS EN 12320 grade 3.

Lloyd Worrall  
Unit 6, Denbigh Hall  
Bletchley  
MILTON KEYNES  
MK3 7QT  
T: 01908 643 364  
F: 01908 643 643  
E: miltonkeynes@lloydworrall.co.uk

Lloyd Worrall  
Unit 13, Chamberlayne Road  
Moreton Hall Ind. Est.  
BURY ST EDMUNDS  
IP32 7EY  
T: 01284 762 002  
F: 01284 762 003  
E: bury@lloydworrall.co.uk

Lloyd Worrall  
Units 10-11, Attercliffe Common Ind. Est.  
Fell Road  
SHEFFIELD  
S9 2AL  
T: 0114 244 3350  
F: 0114 244 4219  
E: sheffield@lloydworrall.co.uk

Lloyd Worrall  
Unit 1, Bentinck Street Ind. Est.  
off Chester Road, Hulme  
MANCHESTER  
M15 4LN  
T: 0161 833 0270  
F: 0161 832 3904  
E: manchester@lloydworrall.co.uk

Lloyd Worrall  
Units 13-16, Noble Street Ind. Est.  
off Scotswood Road  
NEWCASTLE UPON TYNE  
NE4 7PD  
T: 0191 226 0888  
F: 0191 226 0803  
E: newcastle@lloydworrall.co.uk

[www.lloydworrall.co.uk](http://www.lloydworrall.co.uk)

Yannedis  
Unit 3, Woodford Trading Estate  
Southend Road  
Woodford Green  
LONDON  
IG8 8HF  
T: 020 8550 8833  
F: 020 8551 0026  
E: ask@yannedis.com

[www.yannedis.com](http://www.yannedis.com)

MB Architectural  
14a Falcon Road  
BELFAST  
BT12 6RD  
T: 028 9038 0200  
F: 028 9038 0201  
E: ask@mbarchitectural.com

[www.mbarchitectural.com](http://www.mbarchitectural.com)