

Hinges

Architectural | Safehinge | Pivot



BS EN1935:2002

BS EN 1935:2002 Single Axis Hinges

Products tested to British and European standards provide greater durability, longer warranty periods, peace of mind and evidence of professional specification.

Under the standard each product is tested and classified accordingly to show its compliance. The identification of an 8-digit code is visible on the individual product. Each digit represents a category and how it measured against the standard to which it was tested.

The standard specifies requirements for single-axis hinges for windows and doors opening only in one direction whose rotation axis is no more than 30mm from the face of the sash or door. It covers fixed pin and lift-off hinges.

Digit 1: Category of use

- 1 = light duty
- 2 = medium duty
- 3 = heavy duty
- 4 = severe duty

Digit 2: Durability

- 3 = 10,000 test cycles, for light duty hinges on windows.
- 4 = 25,000 test cycles, for light duty hinges on windows and doors.
- 7 = 200,000 test cycles, for medium, heavy and severe duty hinges on doors only.

Digit 3: Test door mass

Test Door Mass Grade	Door Mass
0	10kg
1	20kg
2	40kg
3	60kg
4	80kg
5	100kg
6	120kg
7	160kg

Digit 4: Suitability for fire/smoke door use

- 0 = not suitable for fire/smoke resistance door assemblies.
- 1 = Suitable for use on fire / smoke resistant door assemblies subject to satisfactory assessment of the contribution of the hinges to the fire resistance of the specified fire / door assemblies.

Digit 5: Safety

Single-axis hinges are required to satisfy the essential requirements of safety in use. Therefore, only grade 1 is identified.

Digit 6: Corrosion resistance to BS EN1670.

- 0 = no defined corrosion resistance.
- 1 = mild resistance.
- 2 = moderate resistance.
- 3 = high resistance.
- 4 = very high resistance.

Digit 7: Security

- 0 = no security.
- 1 = suitable for applications requiring a degree of security.

Digit 8: Hinge grade

A summary of the 14 grades are listed in the table below, the full classification can be found in the full standard.

Hinge Grade	Window / Door	Test Cycles	Door Mass
1	window	10,000	10kg
2	window	10,000	20kg
3	window/door	25,000	20kg
4	door	200,000	20kg
5	window	10,000	40kg
6	door/window	25,000	40kg
7	door	200,000	40kg
8	window	10,000	60kg
9	window/door	25,000	60kg
10	door	200,000	60kg
11	door	200,000	80kg
12	door	200,000	100kg
13	door	200,000	120kg
14	door	200,000	160kg

Example:

2 7 3 1 1 3 1 10

The above code signifies a single-axis hinge for use in medium duty situations, tested to 200,000 cycles, for use on doors with a mass up to 60kg, with stated fire door suitability, high corrosion resistance, suitable for burglar-resistant doors, and with a hinge grading of 10.

Marking:

This standard requires that each single-axis hinge manufactured to the standard be marked with the following:

- a: manufacturer's name or trademark, or other means of identification.
- b: the hinge grade.
- c: number of this European standard.

Macnaughton Blair Architectural Division has checked with sources believed to be reliable in their efforts to provide information that is accurate, comprehensive and timely at the date of publication. However, changes can and will occur. Macnaughton Blair Architectural Division expressly disclaims any representation or warranty, expressed or implied, concerning the accuracy, comprehensiveness, or suitability of the information for a particular purpose. Macnaughton Blair Architectural Division has produced this document in good faith and is not responsible for any error, omissions, or results obtained from the use of this document.

Technical Considerations

Fixing Position:

Normally three hinges are fitted to each door. Their positions are determined by the weight of the door and its resistance to warping or whipping.

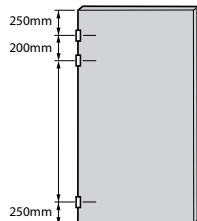

Standard Doors

The standard positioning when fitting three hinges to a door is as shown. This gives the most effective load bearing capability.

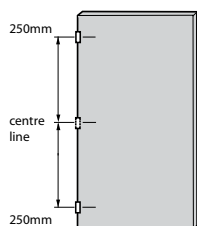

Lightweight Doors

Three hinges may be fitted as shown. On doors subject to warping (such as glazed doors), fit a third hinge at the centre of the door.

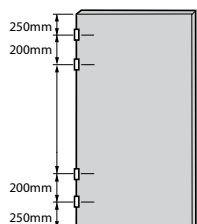

Heavy Doors

When load bearing is the prime consideration, fit four hinges as shown.

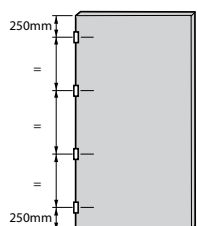

Tall Doors (over 2100mm)

On tall doors or those which are particularly subject to warping (such as glazed doors) fit four hinges equally spaced, as shown.

Hinge specification is also determined by the adjusted door weight. We recommend wherever possible the actual weight be supplied by the door manufacturer. Should this information not be available please contact us.

Adjusted Door Weight Calculation Table			
Actual Door Weight	Doors of excess width, please refer to Side Loading Calculation table		= Adjusted Door Weight
	Door Closer	+20%	
	Door Closer (Backcheck)	+100%	
	Extra Heavy Use Light Use	+10% -10%	

Hinges for use with Door of Excess Widths:

Wider doors increase the bending moment acting on the hinges and should be allowed for by a reduction in the maximum mass of door leaf supported by each class of hinge.

The factor by which the door mass has to be adjusted for excessive widths of doors is calculated by dividing the door height by the door width. For a factor of 2 or greater no allowance has been made, when the factor is less than 2 the door mass had to be increased by the value required to bring the factor to 2 expressed as a percentage.

These percentages are shown in the Side Loading Calculations table below.

Side Loading Calculations			
Door size		Factor	Normal increase of mass of door leaf %
Door height mm	Door width mm		
2000	1000	2	0
2000	1050	1.9	10
2000	1100	1.82	18
2000	1150	1.74	26
2000	1200	1.66	33
2000	1250	1.6	40

Architectural Hinges



Typical bearing butt hinges satisfy the majority of standard internal and external applications. Tested to BS EN1935 Grade 13. Non removable pin.

Manufactured in Grade 304 stainless steel available in Grade 316 to special order.

Concealed bearing hinges are suitable for extreme and secure usage with exceptional load-bearing capabilities. Tested to and exceeding the requirements of BS EN1935 Grade 13 with a full 25 year warranty.

Concealed Bearing

IH002

102 x 89mm
 Concealed bearing knuckle hinge.
 BS EN1935 Grade 13
 CE Marked.
 Certifire Approved.
 25 year warranty.

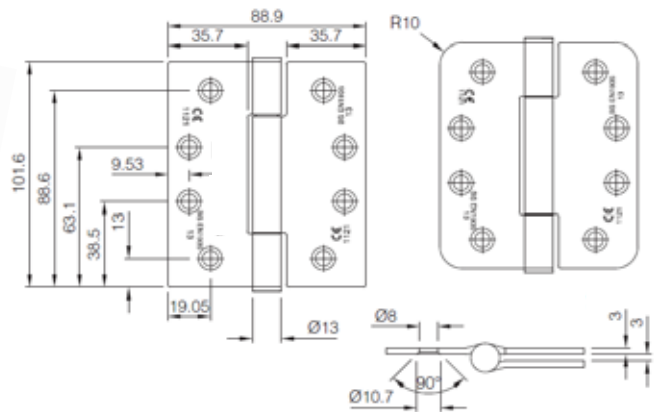

Ball Bearing

IH004

102 x 76 x 2.5mm
 2 Bearing Hinge
 120kg – BS EN1935 Grade 13
 CE Marked.
 Certifire Approved.
 Available with square or radius corners.

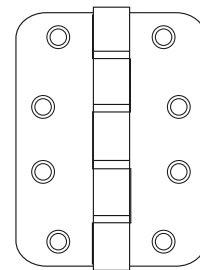

FINISHES

Satin stainless steel.
 Stainless brass.
 Polished stainless steel.
 Satin xinc (IH002).



STANDARDS

BS EN1935 Grade 13.
 CE Marked.
 Certifire Approved.



FIXINGS

Supplied with appropriate woodscrews.
 Security or machine screws available.

Architectural Hinges

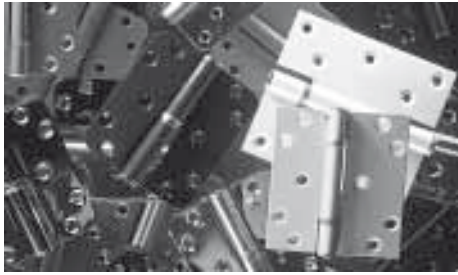

Architectural hinges offer a variety of applications and finishes for any building. Independently tested to BS EN1935. Suitable for heavy and medium duty use, fire doors and excessively weighted doors.

As testimony to the quality of manufacture, these hinges are available with guarantee periods of up to 25 years. Please ask for details.

Square Corner

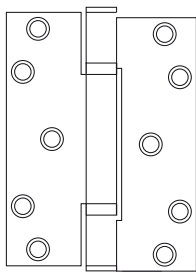

IH006-S-A

10mm Radius Corner

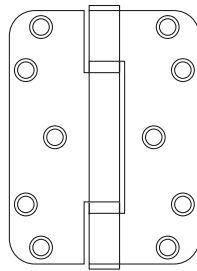

IH006-R-B

Equal Leaf Hinge:
100mm x 88mm
120kg Capacity

BS EN1935 Grade 13.

Minimum Door Thickness 44mm

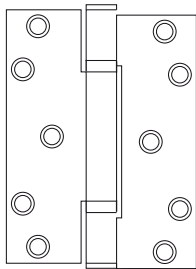

IH006-S-D

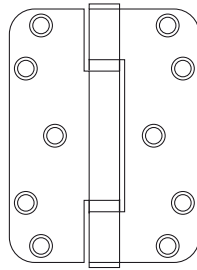

IH006-R-E

Equal Leaf Hinge:
125mm x 111mm
160kg Capacity

Minimum Door Thickness 54mm

BS EN1935 Grade 12.



FINISHES

Bright zinc, polished chrome, satin zinc, polished brass, satin stainless steel, electro brass, polished stainless steel.
Any RAL colour.



FIXINGS

Supplied with woodscrews. Security screws and machine screws available to order.



STANDARDS

25 year guarantee, please ask for details.
BSEN 1935.
CE Marked.
Certifire Approved.

Architectural Hinges

Square Corner

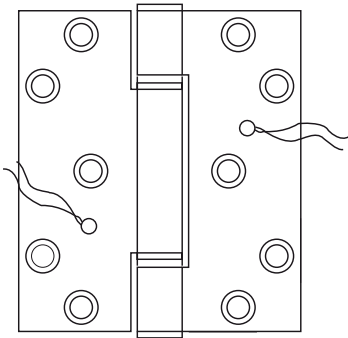

IH006-S-C 2 Wire
IH006-S-C 4 Wire

Radius Corner

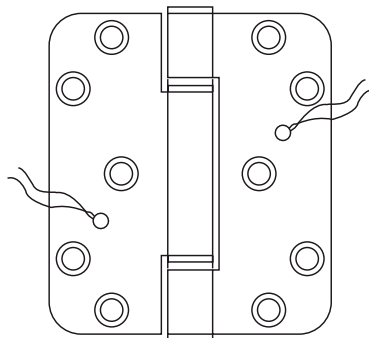

IH006-R-C 2 Wire
IH006-R-C 4 Wire

Conductor Hinge:
100mm x 88mm 80kg Capacity

Wire Length:
500mm Frameleaf 1000mm Doorleaf

(8 wire and 12 wire options available)

Maximum Voltage: 24v.
Maximum Current: 2.0 amp per conductor.
Number of Conductors: 2 minimum – 4 maximum.

High Temperature Wire: Silver plated copper strands with PTFE insulation to BS2G 210.
High thermal and chemical stability.
Tested for 500,000 cycles at 80kg loading.

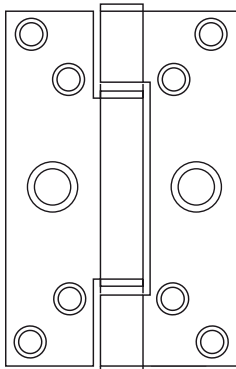

IH006-S-SD

Security Dog
Bolt Hinge
100mm x 88mm
120kg capacity

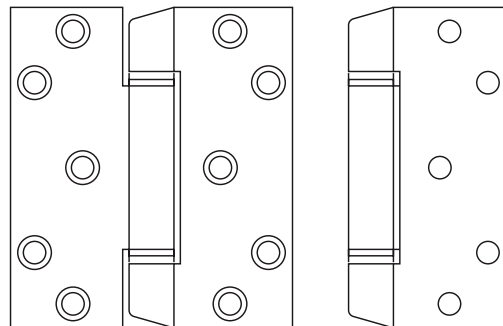

IH006-S-AL

Anti-ligature or
Hospital Corner Hinge
100mm x 88mm
120kg capacity

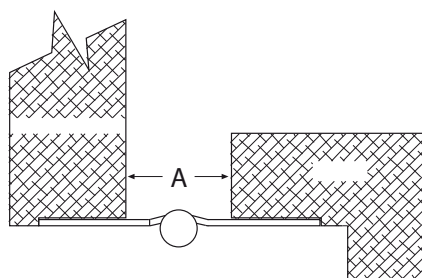
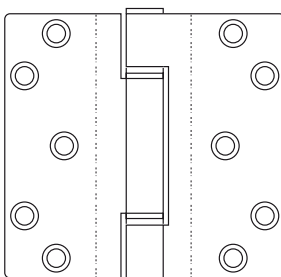

Projection Hinges
80kg capacity

IH006-S-P-A 100mm x 106mm (A = 40mm)

IH006-S-P-B 100mm x 124mm (A = 58mm)



FINISHES

Bright zinc, polished chrome, satin zinc, polished brass, satin stainless steel, electro brass, polished stainless steel.
Any RAL colour.



STANDARDS

25 year guarantee, please ask for details.
BSEN 1935.
CE Marked.
Certifire Approved.



FIXINGS

Supplied with woodscrews. Security screws and machine screws available to order.

Journal Supported Lift Off Hinges



Lift-off hinges are ideal for factory prepared doorsets.

They have same load-bearing capacity as butt hinges and have been successfully included in fire tests and tested to BS EN 1935.

With lift off hinges on-site maintenance becomes easier.

Used extensively in hospitals, schools and other high traffic installations.

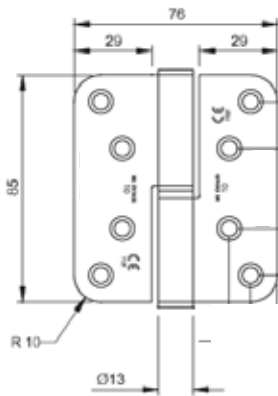

85mm x 76mm x 2.64mm
BS EN 1935 Grade 10

IH007-R-L left hand
IH007-R-R right hand

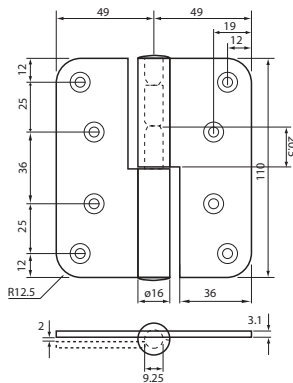
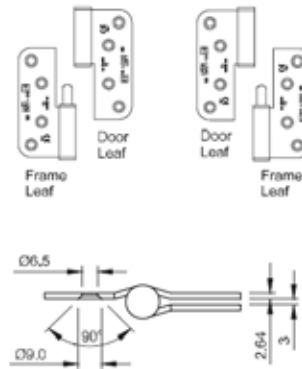

110mm x 98mm x 3.1mm
BS EN 1935 Grade 13

IH003-R-L left hand
IH003-R-R right hand

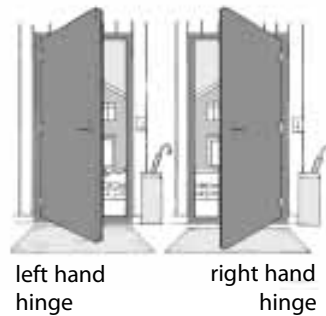

left hand hinge

right hand hinge



FINISHES

Satin stainless steel, Polished stainless steel.
Bright zinc plated, yellow zinc iron and lacquer.
Standard RAL colours.



STANDARDS

BS EN 1935.
CE Marked.
Certifire Approved.



FIXINGS

Matching wood screws.



OPTIONS

1mm adjustment disc. Note: maximum of 3mm per door, then seek technical advice.

Standard Butt Hinges

Steel Butt Hinges

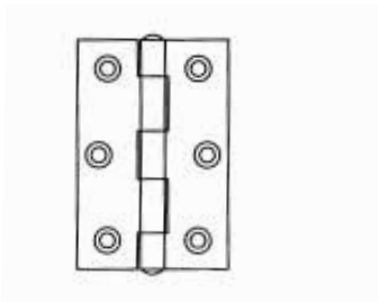

IH008
Standard Butt Hinge
75mm x 49mm x 2mm
20kg Capacity

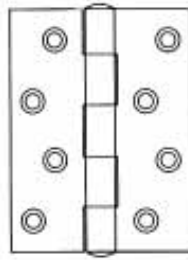

IH005
Standard Butt Hinge
102mm x 76mm x 2.5mm
40kg Capacity
BS EN 1935 Grade 7. CE Marked. Certifire.

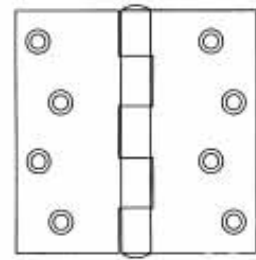

IH009
Broad Butt Hinge
102mm x 102mm x 2.5mm
40kg Capacity

Brass Washered Butt Hinges

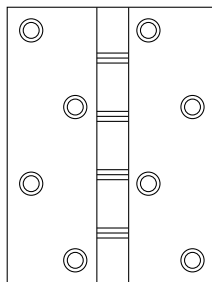

Phosphur Bronze Washers

75mm x 50mm
IH010-PBW

100mm x 65mm
IH011-PBW

100mm x 75mm
IH012-PBW

Stainless Steel Washers

75mm x 50mm
IH010-DSSW

100mm x 65mm
IH011-DSSW

100mm x 75mm
IH012-DSSW

Steel Rising Butt Hinge

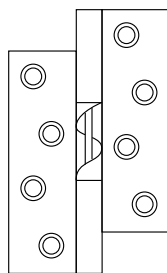

75mm
IH013-A

100mm
IH013-B

Steel Falling Butt Hinge

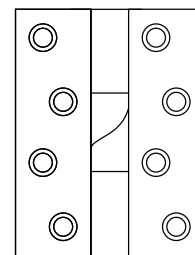

75mm
IH014-A

100mm
IH014-B



FINISHES

Steel – Self color, bright zinc, electro brased, standard RAL colours.
Brass – Self colour, polished brass.
Chrome – Polished chrome, satin chrome.



STANDARDS

Standards as shown where applicable.



FIXINGS

Supplied with matching woodscrews.

Pivot sets, Emergency release stops

EMERGENCY RELEASE STOP

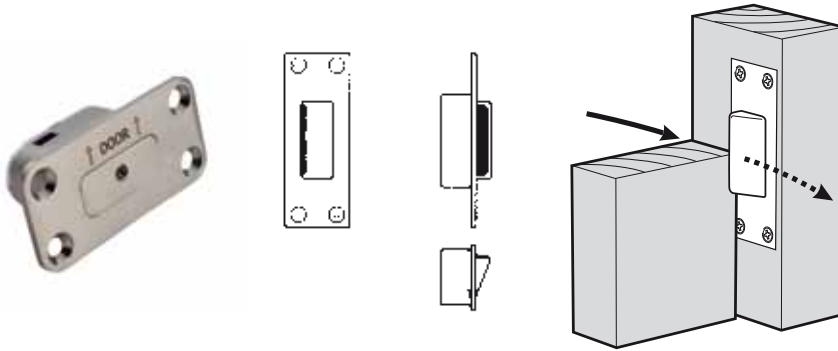

When used in conjunction with the pivot set, the emergency release stop allows the door to be opened in the opposite direction to that which it normally operates. In the event of an emergency the stop can be depressed allowing the door to be opened past it. The stop then resets automatically.

IH101-A Emergency release stop

IH101-B Fixed unit with removable allen screw, ok for restricting use

DOUBLE ACTION STRIKE PLATE

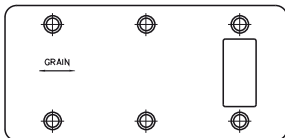

IH101-P-A

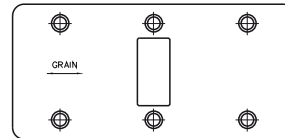

IH101-P-B

Plates can be pierced to suit exact door position within the frame. Dimensions to be advised.

STANDARD DUTY PIVOT SET

HEAVY DUTY PIVOT SET

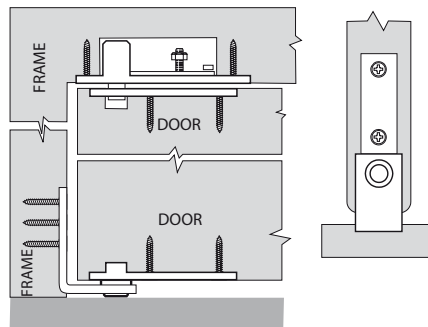

IH102-A 80kg capacity

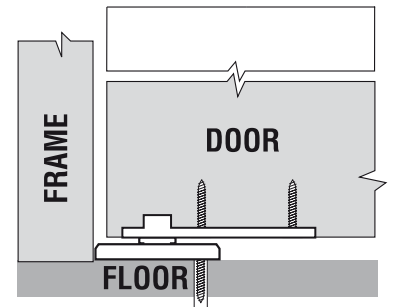

IH102-B 120kg capacity



FINISHES

Satin stainless steel.



FIXINGS

All necessary fixings supplied.

Safehinge ALU



Safehinge ALU integrates severe duty door hanging with anti trap finger protection which offers a very competitive whole life cost solution as an alternative to plastic or fabric variants.

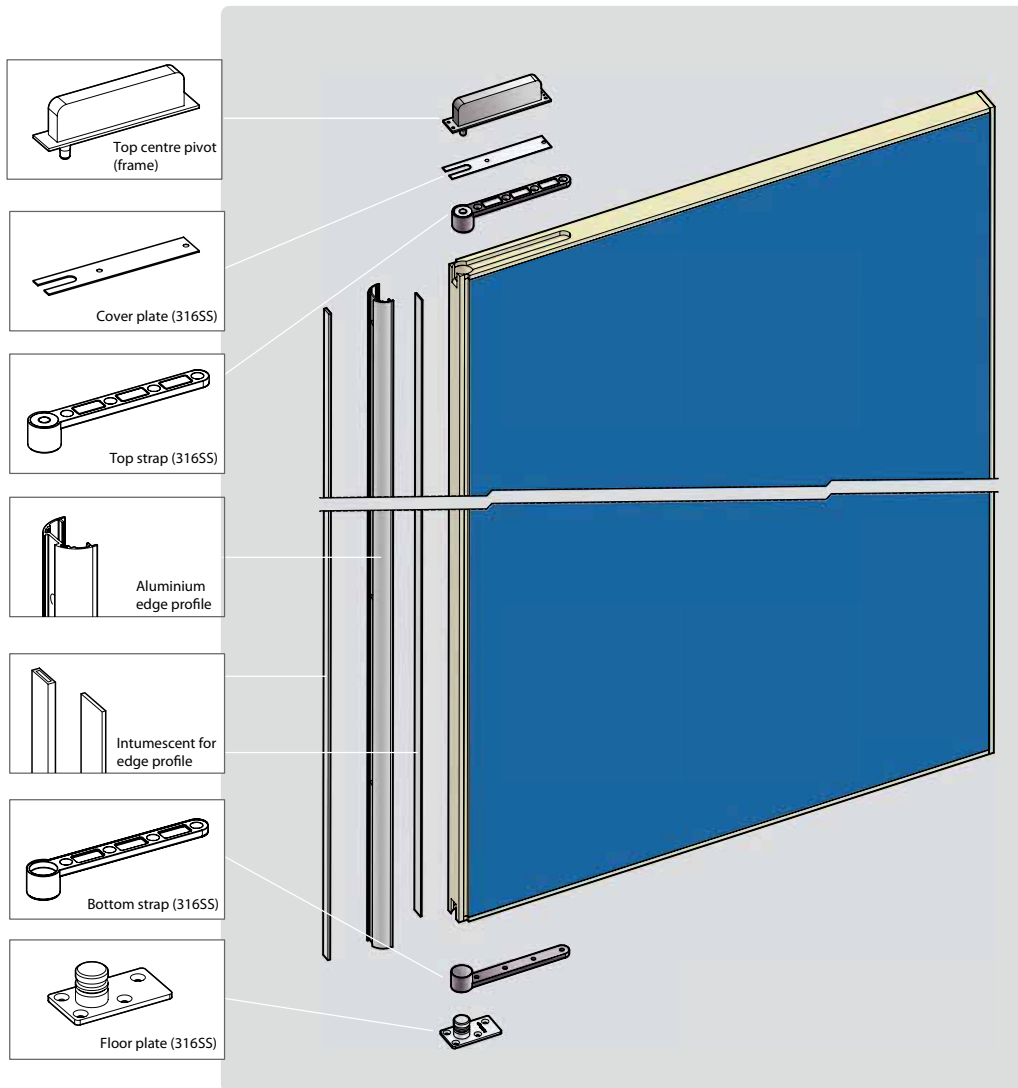

IH001

Safehinge ALU versions are available for 44 and 54mm thick doors for NFR/FD30/FD60 rating.

Please contact us to discuss sizes and specific dimensions.



NFR/FD30/FD60



SEVERE DUTY



UP TO 38dB



RAL COLOUR OPTIONS

Lloyd Worrall
Unit 6, Denbigh Hall
Bletchley
MILTON KEYNES
MK3 7QT
T: 01908 643 364
F: 01908 643 643
E: miltonkeynes@lloydworrall.co.uk

Lloyd Worrall
Unit 13, Chamberlayne Road
Moreton Hall Ind. Est.
BURY ST EDMUNDS
IP32 7EY
T: 01284 762 002
F: 01284 762 003
E: bury@lloydworrall.co.uk

Lloyd Worrall
Units 10-11, Attercliffe Common Ind. Est.
Fell Road
SHEFFIELD
S9 2AL
T: 0114 244 3350
F: 0114 244 4219
E: sheffield@lloydworrall.co.uk

Lloyd Worrall
Unit 1, Bentinck Street Ind. Est.
off Chester Road, Hulme
MANCHESTER
M15 4LN
T: 0161 833 0270
F: 0161 832 3904
E: manchester@lloydworrall.co.uk

Lloyd Worrall
Units 13-16, Noble Street Ind. Est.
off Scotswood Road
NEWCASTLE UPON TYNE
NE4 7PD
T: 0191 226 0888
F: 0191 226 0803
E: newcastle@lloydworrall.co.uk

www.lloydworrall.co.uk

Yannedis
Unit 3, Woodford Trading Estate
Southend Road
Woodford Green
LONDON
IG8 8HF
T: 020 8550 8833
F: 020 8551 0026
E: ask@yannedis.com

www.yannedis.com

MB Architectural
14a Falcon Road
BELFAST
BT12 6RD
T: 028 9038 0200
F: 028 9038 0201
E: ask@mbarchitectural.com

www.mbarchitectural.com